

**Automatic Blood Pressure Monitor
Model HEM-7221
Instruction Manual**



A Good Sense of Health

Contents

Before using the unit

Introduction	3
Important Safety Information	4
1. Overview	7
2. Preparation	10
2.1 Installing/Replacing the Batteries	10
2.2 Setting the Date and Time	11

Operating instructions

3. Using the Unit	12
3.1 Applying the Arm Cuff	12
3.2 How to Sit Correctly	14
3.3 Taking a Reading	15
3.4 Using the Memory Function	18
4. Troubleshooting and Maintenance	20
4.1 The Icons and Error Messages	20
4.2 Troubleshooting	22
4.3 Maintenance	24
4.4 Storage	25

Care and maintenance

5. Optional Parts	26
6. Technical Data	27

Introduction

Thank you for purchasing the OMRON HEM-7221 Automatic Blood Pressure Monitor.

The OMRON HEM-7221 is a compact, fully automatic blood pressure monitor, operating on the oscillometric principle. It measures your blood pressure and pulse rate simply and quickly. Equipped with Dual Check System and Cuff Wrapping Guide, HEM-7221 provides accurate and anxiety-free blood pressure measurement everyday. For comfortable controlled inflation without the need of pressure pre-setting or re-inflation the device uses its advanced "IntelliSense" technology.

Please read this instruction manual thoroughly before using the unit.



Please keep for future reference.

For specific information about your own blood pressure, CONSULT YOUR DOCTOR.

Important Safety Information

Consult your doctor prior to using in pregnancy or if diagnosed with arrhythmia or arteriosclerosis.

Please read this section carefully before using the unit.

Warning:

- Indicates a potentially hazardous situation which, if not avoided, could result in death or serious injury.

(General Usage)

- Always consult your doctor. Self-diagnosis of measurement results and self-treatment are dangerous.
- People with severe blood flow problems, or blood disorders, should consult a doctor before using the unit, as cuff inflation can cause internal bleeding.

(AC Adapter Usage)

- Never plug in or unplug the power cord from the electric outlet with wet hands.

(Battery Usage)

- If battery fluid should get in your eyes, immediately rinse with plenty of clean water. Consult a doctor immediately.

Caution:

- Indicates a potentially hazardous situation which, if not avoided, may result in minor or moderate injury to the user or patient or damage to the equipment or other property.

Important Safety Information

(General Usage)

- Do not leave the unit unattended with infants or persons who cannot express their consent.
- Do not use the unit for any purpose other than measuring blood pressure.
- Use only the approved arm cuff for this unit. Use of other arm cuffs may result in incorrect measurement results.
- Make sure that the air tube is not wrapped around other parts of your body when taking measurements at night. This could result in injury when the air pressure in the air tube is increased.
- Do not leave the cuff wrapped on the arm if taking measurements during the night. This could result in injury.
- Do not inflate the arm cuff over 299 mmHg.
- Do not use a mobile phone or other devices that emit electromagnetic fields, near the unit. This may result in incorrect operation of the unit.
- Do not operate the unit in a moving vehicle (car, airplane).
- To inflate the cuff manually, refer to Section 3.3. If the cuff is over inflated, it can cause internal bleeding.

(AC Adapter Usage)

- Use only the original AC adapter (optional) designed for this unit. Use of unsupported adapters may damage and/or may be hazardous to the unit.
- Plug the AC adapter into the appropriate voltage outlet. Do not use a multiple-tap.
- Do not use the AC adapter if the unit or the power cord is damaged. Turn off the power and unplug the power cord immediately.

Important Safety Information

(Battery Usage)

- If battery fluid should get on your skin or clothing, immediately rinse with plenty of clean water.
- Use only four "AA" alkaline or manganese batteries with this unit. Do not use other types of batteries.
- Do not insert the batteries with their polarities incorrectly aligned.
- Replace old batteries with new ones immediately. Replace all four batteries at the same time.
- Remove the batteries if the unit will not be used for three months or more.
- Do not use new and used batteries together.

General Precautions

- Do not apply strong shocks and vibrations to or drop the unit and arm cuff.
- Do not take measurements after bathing, drinking alcohol or caffeine, smoking, exercising or eating.
- Do not forcibly bend the arm cuff or bend the air tube excessively.
- When removing the air tube, pull on the air plug at the connection with the main unit not the tube itself.
- Do not inflate the arm cuff when it is not wrapped around your arm.

1. Overview

Main Unit:

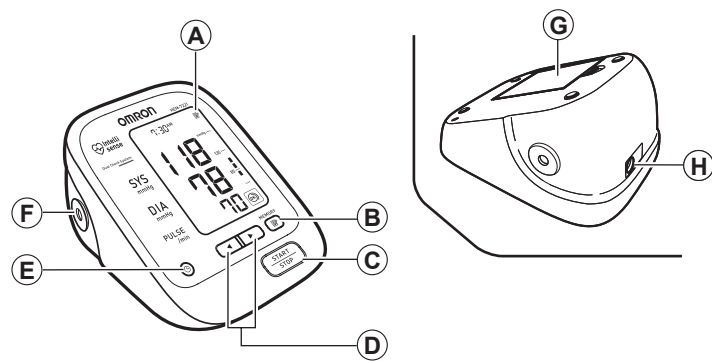

- A. Display
- B. Memory button
- C. START/STOP button
- D. Up/Down (◀/▶) buttons
- E. Date/Time setting (⌚) button
- F. Air Jack

- G. Battery compartment
- H. AC adapter jack (for optional AC adapter)

1. Overview

Arm Cuff:

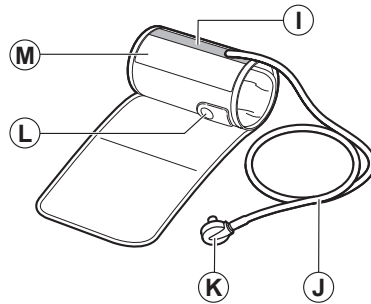

- I. Blue Strip
- J. Air tube
- K. Air plug
- L. Grip
- M. Arm cuff
(Cuff: arm circumference 17-32 cm)

Storage case:

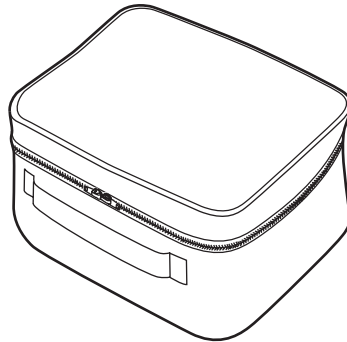

Display:

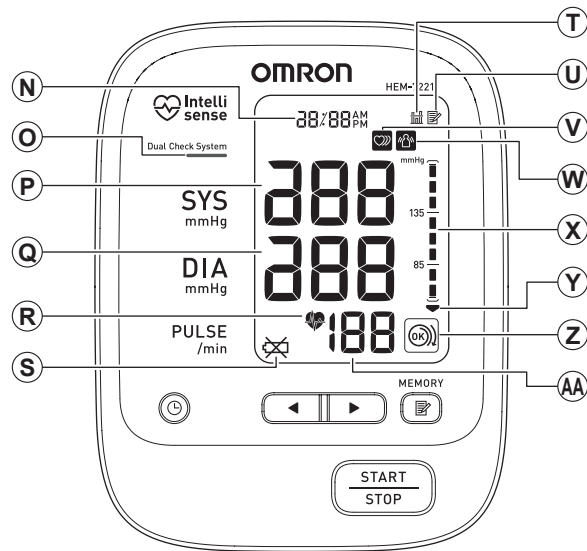

- | | |
|---|--|
| N. Date/Time display | T. Average value symbol |
| O. Dual Check System | U. Memory symbol |
| P. Systolic blood pressure | V. Irregular heartbeat symbol |
| Q. Diastolic blood pressure | W. Movement error symbol |
| R. Heartbeat symbol
(Flashes during measurement) | X. Blood pressure level indicator |
| S. Battery low symbol | Y. Deflation symbol |
| | Z. Cuff wrapping guide |
| | AA. Pulse display and Memory
number |

2. Preparation

2.1 Installing/Replacing the Batteries

1. Remove the battery cover.
2. Insert four "AA" batteries as indicated in the battery compartment and then replace the battery cover.

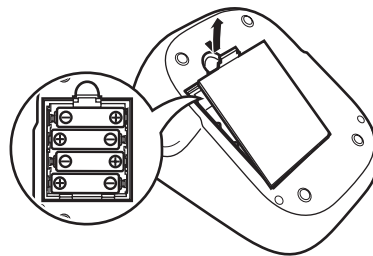

Notes:

- If the battery low symbol (⊗) appears on the display, turn the unit off then replace all batteries at the same time.
- The measurement values continue to be stored in memory even after the batteries are replaced.

Disposal of used batteries should be carried out in accordance with the national regulations for the disposal of batteries.

2.2 Setting the Date and Time

1. Press the  button.
2. Set the monitor to the correct date and time before taking a measurement for the first time.

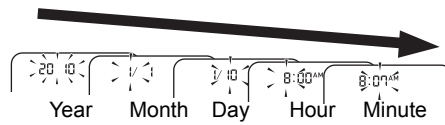
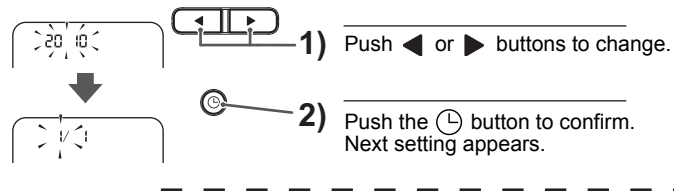

3. Press the START/STOP button to store the setting.

Notes:

- If the batteries have been removed for 30 seconds or more, the date and time setting will need to be reset.
- If the date and time are not set, "--:--" appears during or after measurement.

3. Using the Unit

3.1 Applying the Arm Cuff

Remove tight-fitting clothing or tight rolled up sleeve from your upper arm.

Do not place the cuff over thick clothes.

1. Insert the air plug into the air jack.

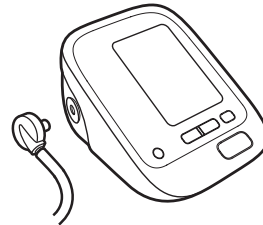

2. Hold the grip on the cuff securely with your hand.



3. Apply the cuff to your upper arm.

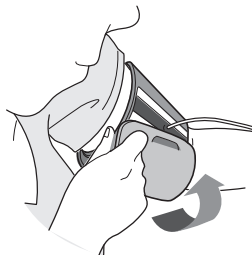

3. Using the Unit

The bottom edge of the cuff should be 1 to 2 cm above the elbow.

Marker (arrow under tube) is centred on the middle of your inner arm.

Close the fabric fastener FIRMLY.

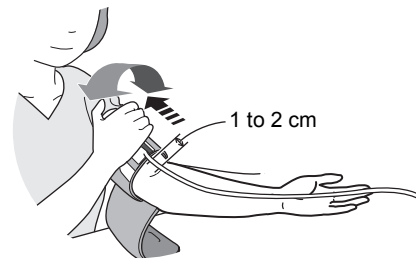

Notes:

- When you take a measurement on the right arm, air tube will be at the side of your elbow. Be careful not to rest your arm on the air tube.
- The blood pressure can differ between the right arm and the left arm, and therefore also the measured blood pressure values can be different. OMRON recommends to always use the same arm for measurement. If the values between the two arms differ substantially, please check with your doctor which arm to use for your measurement.

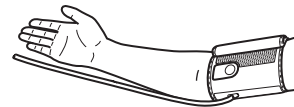

3. Using the Unit

3.2 How to Sit Correctly

To take a measurement, you need to be relaxed and comfortably seated, under comfortable room temperature. No bathing, drinking alcohol or caffeine, smoking, exercising or eating 30 minutes before taking a measurement.

- Sit on a chair with your feet flat on the floor.
- Sit upright with your back straight.
- The cuff should be at the same level as your heart.

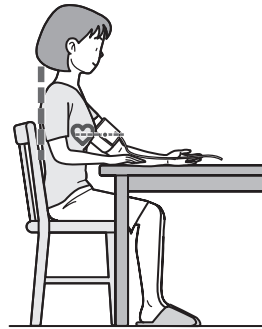

3.3 Taking a Reading

Notes:

- To cancel a measurement, press the START/STOP button to turn the unit off and to release the air in the arm cuff.
- Remain still while taking a measurement.

1. Press the START/STOP button.
The cuff will start to inflate automatically.

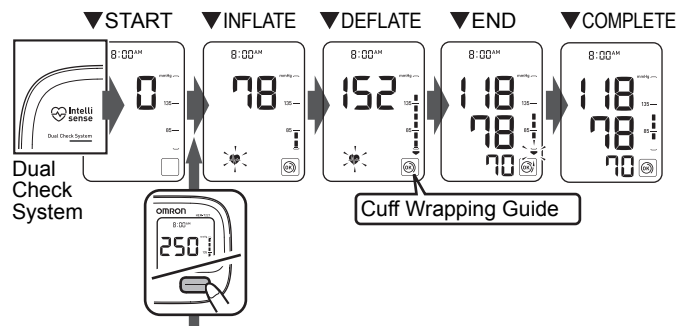

If your systolic pressure is more than 220 mmHg

After the cuff starts to inflate, press and hold the START/STOP button until the monitor inflates 30 to 40 mmHg higher than your expected systolic pressure.

Notes:



- The monitor will not inflate above 299 mmHg.
- Do not apply more pressure than necessary.

Dual Check System

Press the START/STOP button, then the Dual Check System lamp lights and the unit starts detecting a device error. If the unit is accurate and functioning correctly, the Dual Check System lamp remains lit during the measurement. If an error is detected, the Dual Check System lamp flashes and "Er" will appear on the display.

3. Using the Unit

Cuff Wrapping Guide

This monitor checks whether the cuff is applied correctly during the inflation. When the cuff is applied correctly,  is displayed while taking a measurement or using the memory function. If the cuff is not applied correctly,  is displayed. Carefully read and repeat the steps listed under section 3.1.

Note: Wait 2-3 minutes before taking another blood pressure measurement. Waiting between readings allows the arteries to return to the condition prior to taking the blood pressure measurement.

⚠ Warning:

Self-diagnosis of measured results and treatment are dangerous.

Please follow the instructions of your doctor.

2. Remove the arm cuff.

3. Press the START/STOP button to turn the monitor off.

The monitor automatically stores the measurement in its memory.

It will automatically turn off after 2 minutes.

Important:

- Recent research suggests that the following values can be used as a guide to high blood pressure for measurements taken at home.

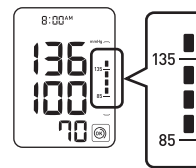

Systolic Blood Pressure	Above 135 mmHg
Diastolic Blood Pressure	Above 85 mmHg

This criteria is for home blood pressure measurement.

3. Using the Unit

- Your blood pressure monitor includes an irregular heartbeat feature. Irregular heartbeats can influence the results of the measurement. The irregular heartbeat algorithm automatically determines if the measurement is usable or needs to be repeated. If the measurement results are affected by irregular heartbeats but the result is valid, the result is shown together with the irregular heartbeat symbol (👊). If the irregular heartbeats cause the measurement to be invalid, no result is shown. If the irregular heartbeat symbol (👊) is shown after you have taken a measurement, repeat the measurement. If the irregular heartbeat symbol (👊) is shown frequently, please make your doctor aware of it.
- If you move during measurement, the movement error symbol (👊) will appear on the display. Keep still and repeat the measurement.



3. Using the Unit

3.4 Using the Memory Function

The monitor automatically stores the result up to 90 sets. It can also calculate an average reading based on the measurements from the last three readings taken within 10 minutes. If there are only two readings in memory for that period, the average will be based on two readings. If there is one reading in memory for that period, the average will be based on one reading.

Notes:

- If the memory is full, the monitor will delete the oldest readings.
- When viewing the reading taken without setting the date and time, “-:--” is displayed instead of the date and time.

To View the Average Value

1. Press the Memory button.

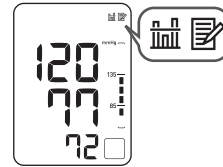

Note: If there are no measurements results stored in the memory, the screen to the right is displayed.

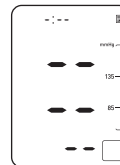

To View the Readings Stored in Memory

1. Press the ◀ button, while the average value is displayed.

The Memory number appears for a second before the pulse rate is displayed. The newest set is numbered "1".

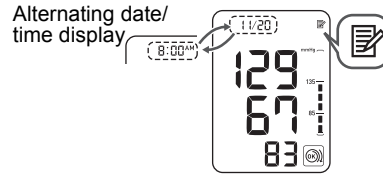

2. Press the ◀ or ▶ button to view the readings stored in memory.

◀: To the older readings

▶: To the more recent readings

To delete all the values stored in memory



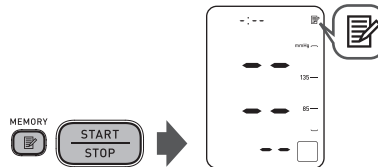

When the memory symbol (📄) appears, first press the Memory button. Then while holding it down, press the START/STOP button simultaneously for about 2-3 seconds.



Note: You cannot partially delete the stored readings.

4. Troubleshooting and Maintenance

4.1 The Icons and Error Messages

Error Display	Cause	Remedy
	Irregular heartbeats are detected.	Remove the arm cuff. Wait 2-3 minutes and then take another measurement. Repeat the steps in section 3.3. If this error continues to appear, contact your doctor.
	Movement during measurement.	Carefully read and repeat the steps in section 3.3.
	Cuff is not applied correctly.	Apply the arm cuff correctly. Refer to section 3.1.
 Blink	The batteries are low.	You should replace them with new ones ahead of time. Refer to section 2.1.
 Lit	The batteries are exhausted.	You should replace them with new ones at once. Refer to section 2.1.
E I	Air plug disconnected.	Insert the plug securely. Refer to section 3.1.
	Arm cuff not applied correctly.	Apply the arm cuff correctly. Refer to section 3.1.
	Air is leaking from the arm cuff.	Replace the cuff with the new one. Refer to Chapter 5.

4. Troubleshooting and Maintenance

Error Display	Cause	Remedy
E2	Cuff over inflated.	Repeat measurement. Remain still and do not talk during measurement. Refer to section 3.3.
		If "E2" appears repeatedly, inflate the cuff manually until it is 30 to 40 mmHg above your previous measurement result. Refer to section 3.3.
E3	The arm cuff was inflated above 299 mmHg when inflating the cuff manually.	Do not inflate the cuff above 299 mmHg. Refer to section 3.3.
E4	Movement during measurement.	Repeat measurement. Remain still and do not talk during measurement. Refer to section 3.3.
E5	Clothing is interfering with the arm cuff.	Remove any clothing interfering with the arm cuff. Refer to section 3.1.
Er	Device error.	Contact your OMRON retail outlet or distributor.

Note: The irregular heartbeat symbol () may also be displayed with error messages.

4. Troubleshooting and Maintenance

4.2 Troubleshooting

Problem	Cause	Remedy
The reading is extremely low (or high).	Arm cuff not applied correctly.	Apply the arm cuff correctly. Refer to section 3.1.
	Movement or talking during measurement.	Remain still and do not talk during measurement. Refer to section 3.3.
	Clothing is interfering with the arm cuff.	Remove any clothing interfering with the arm cuff. Refer to section 3.1.
Arm cuff pressure does not rise.	The air tube is not securely connected into the main unit.	Make sure that the air tube is connected securely. Refer to section 3.1.
	Air is leaking from the arm cuff.	Replace the arm cuff with a new one. Refer to Chapter 5.
Arm cuff deflates too soon.	The arm cuff is loose.	Apply the cuff correctly so that it is firmly wrapped around the arm. Refer to section 3.1.
Cannot measure or readings are too low or too high.	The arm cuff has not been inflated sufficiently.	Inflate the cuff so that it is 30 to 40 mmHg above your previous measurement result. Refer to section 3.3.
Nothing happens when you press the buttons.	The batteries are empty.	Replace the batteries with new ones. Refer to section 2.1.
	The batteries have been inserted incorrectly.	Insert the batteries with the correct (+/-) polarity. Refer to section 2.1.

4. Troubleshooting and Maintenance

Problem	Cause	Remedy
Other problems.		<ul style="list-style-type: none">• Press the START/STOP button and repeat measurement.• If the problem continues, try replacing the batteries with new ones. If this still does not solve the problem, contact your OMRON retail outlet or distributor.

4. Troubleshooting and Maintenance

4.3 Maintenance

To protect your unit from damage, please observe the following:

- Do not subject the main unit and the cuff to extreme temperatures, humidity, moisture or direct sunlight.
- Do not fold the cuff or tubing tightly.
- Do not disassemble the unit.
- Do not subject the unit to strong shocks or vibrations (for example, dropping the unit on the floor).
- Do not use volatile liquids to clean the main unit. The unit should be cleaned with a soft, dry cloth.
- Use a soft, moistened cloth and soap to clean the arm cuff.
- Do not wash the arm cuff or immerse it in water.
- Do not use petrol, thinners or similar solvents to clean the arm cuff.

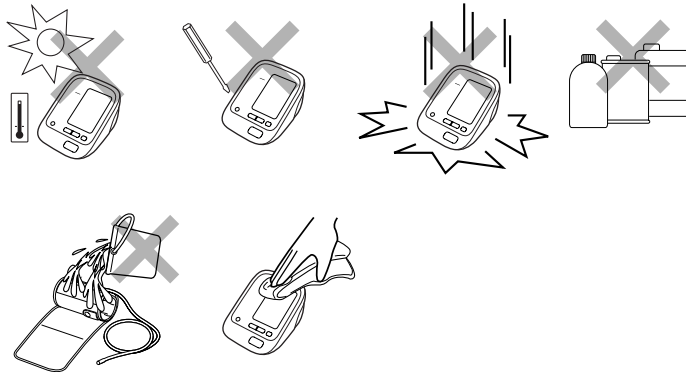

- Do not carry out repairs of any kind yourself. If a defect occurs, consult your local authorised OMRON distributor or dealer.

Calibration and Service

- The accuracy of this blood pressure monitor has been carefully tested and is designed for a long service life.
- It is generally recommended to have the unit inspected every two years to ensure correct functioning and accuracy. Please consult your local authorised OMRON distributor or dealer.

4.4 Storage

Keep the unit in its storage case when not in use.

1. Unplug the air plug from the air jack.
2. Gently fold the air tube into the arm cuff.

Note: Do not bend the air tube excessively.

3. Place the arm cuff and main unit in the storage case.

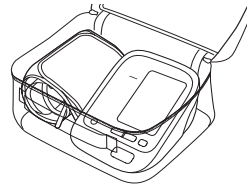

Do not store the unit in the following situations:

- If the unit is wet.
- Locations exposed to extreme temperatures, humidity, direct sunlight, dust or corrosive vapours.
- Locations exposed to vibrations, shocks or where it will be at an angle.

5. Optional Parts

Small-Medium Arm Cuff
Arm circumference
17-32 cm



Medium-Large Arm Cuff
Arm circumference
22 - 42 cm

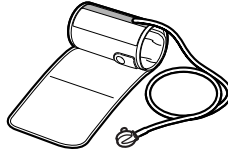

AC Adapter "R"

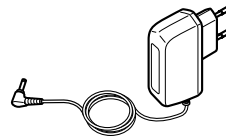

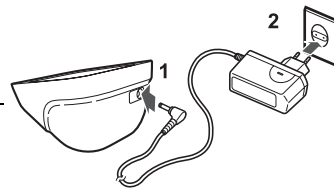

Using the Optional AC Adapter

1. Insert the AC adapter plug into the AC adapter jack on the rear side of the main unit.
2. Plug the AC adapter into an electrical outlet.



To disconnect the AC adapter, unplug the AC adapter from the electrical outlet first and then remove the AC adapter plug from the main unit.

6. Technical Data

Product Description	Automatic Blood Pressure Monitor
Model	HEM-7221
Display	LCD Digital Display
Measurement Method	Oscillometric method
Measurement Range	Pressure: 0 to 299 mmHg Pulse: 40 to 180/min.
Accuracy	Pressure: ± 3 mmHg Pulse: $\pm 5\%$ of display reading
Inflation	Fuzzy-logic controlled by electric pump
Deflation	Automatic pressure release valve
Pressure Detection	Capacitive pressure sensor
Memory	90 Measurements with date and time
Rating	DC6V \approx 4W
Power Source	4 "AA" batteries 1.5V or AC adapter (R Adapter-9997605-0 (optional), INPUT AC100-240V 50/60Hz 0.1A)
Battery Life	Capacity of new alkaline batteries is approx. 1000 measurements
Applied Part	 = Type B
Protection Against Electric Shock	Internally powered ME equipment (When using only the batteries)  = Class II ME equipment (Optional AC adapter)
Operating temperature/ Humidity	+10°C to +40°C / Maximum: 30 to 85% RH
Storage temperature/ Humidity/ Air pressure	-20°C to +60°C / Maximum: 10 to 95% RH / 700-1060 hPa
Console Weight	Approximately 380g without batteries
Cuff Weight	Approximately 240g
Outer Dimensions	Approximately 123 (w) mm \times 85 (h) mm \times 158 (l) mm
Cuff Dimensions	Approximately 152 mm \times 600 mm (Cuff: arm circumference 17 to 32 cm)
Cuff Material	Nylon and polyester
Package Content	Main unit, cuff, instruction manual, storage case, battery set

Notes:

- Subject to technical modification without prior notice.
- Disposal of this product and used batteries should be carried out in accordance with the national regulations for the disposal of electronic products.

6. Technical Data

CE0197

- This device fulfils the provisions of EC directive 93/42/EEC (Medical Device Directive).
- This blood pressure monitor is designed according to the European Standard EN1060, Noninvasive sphygmomanometers Part 1: General Requirements and Part 3: Supplementary requirements for electromechanical blood pressure measuring systems.

Important information regarding Electro Magnetic Compatibility (EMC)

With the increased number of electronic devices such as PC's and mobile (cellular) telephones, medical devices in use may be susceptible to electromagnetic interference from other devices. Electromagnetic interference may result in incorrect operation of the medical device and create a potentially unsafe situation.

Medical devices should also not interfere with other devices.

In order to regulate the requirements for EMC (Electro Magnetic Compatibility) with the aim to prevent unsafe product situations, the EN60601-1-2:2007 standard has been implemented. This standard defines the levels of immunity to electromagnetic interferences as well as maximum levels of electromagnetic emissions for medical devices.

This medical device manufactured by OMRON Healthcare conforms to this EN60601-1-2:2007 standard for both immunity and emissions.

Nevertheless, special precautions need to be observed:

- Do not use mobile (cellular) telephones and other devices, which generate strong electrical or electromagnetic fields, near the medical device. This may result in incorrect operation of the unit and create a potentially unsafe situation. Recommendation is to keep a minimum distance of 7 m. Verify correct operation of the device in case the distance is shorter.

Further documentation in accordance with EN60601-1-2:2007 is available at OMRON Healthcare Europe at the address mentioned in this instruction manual.

Documentation is also available at www.omron-healthcare.com.

Correct Disposal of This Product (Waste Electrical & Electronic Equipment)

This marking shown on the product or its literature, indicates that it should not be disposed of, with other household wastes at the end of its working life. To prevent possible harm to the environment or human health from uncontrolled waste disposal, please separate this from other types of wastes and recycle it responsibly to promote the sustainable reuse of material resources.

Household users should contact either the retailer where they purchased this product, or their local government office, for details of where and how they can take this item for environmentally safe recycling.

Business users should contact their supplier and check the terms and conditions of the purchase contract. This product should not be mixed with other commercial wastes for disposal.

This product does not contain any hazardous substances.



	OMRON HEALTHCARE Co., Ltd. 24, Yamanouchi Yamanoshita-cho, Ukyo-ku, Kyoto 615-0084, JAPAN		
<table border="1"><tr><td>EC</td><td>REP</td></tr></table>	EC	REP	OMRON HEALTHCARE EUROPE B.V. Kruisweg 577, 2132 NA Hoofddorp THE NETHERLANDS www.omron-healthcare.com
EC	REP		
Asia Pacific HQ	OMRON HEALTHCARE SINGAPORE PTE LTD. 438A Alexandra Road, #05-05/08, Alexandra Technopark, Singapore 119967		

5327840-4B