

# OMRON®

## INSTRUCTION MANUAL

COMP *A-I-R*™ Pro

# Compressor Nebulizer

## Model NE-C29

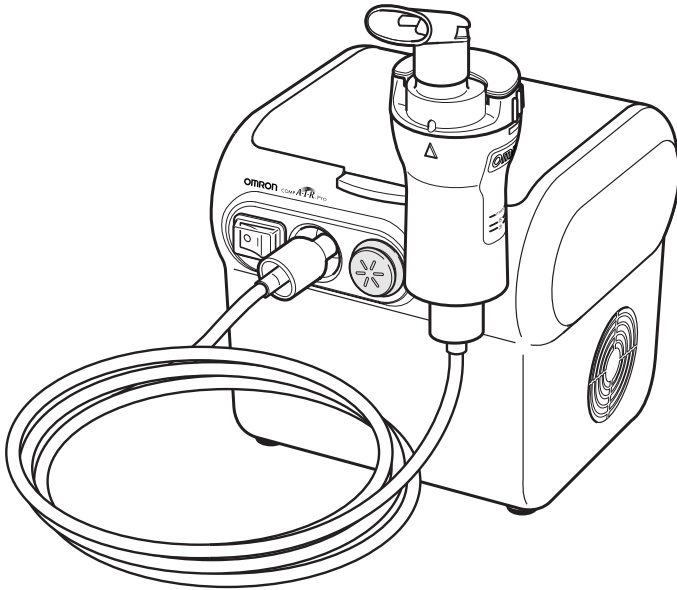

**A Good Sense of Health**

# CONTENTS

## Before Using the Unit

Important Safety Notes .....	2
Know Your Unit .....	5
Guide to Using the NE-C29 .....	7

## Operating Instructions

How to Prepare the Nebulizer for Use .....	8
How to Take Medication .....	12

## Care and Maintenance

Cleaning and Daily Disinfecting .....	15
Maintenance and Storage .....	16
How to Change the Air Filter .....	18
Troubleshooting Tips .....	19
Specifications .....	20
Optional Parts and Accessories .....	21
Notes .....	22

# IMPORTANT SAFETY NOTES

To assure the correct use of the product basic safety measures should always be followed including the precautions listed below:

## **⚠ WARNING:**

Indicates a potentially hazardous situation which, if not avoided, could result in death or serious injury.

### ***(Usage)***

- ☑ For type, dose, and regime of medication follow the instructions of your doctor or respiratory therapist.
- ☑ Clean and disinfect the nebulizer kit, mouthpiece and optional nosepiece or masks before using them for the first time after purchase, if the device has not been used for a long period of time.
- ☑ If the device is used by more than one person, be sure to clean and disinfect parts before they are used by each person.
- ☑ Always dispose of any remaining medication after use, and use fresh medication each time.
- ☑ Do not use only water in the nebulizer, for nebulizing purposes.
- ☑ Do not use the device where it may be exposed to flammable gas.
- ☑ Do not block the ventilation slots. Never place the device where the ventilation slots may be obstructed during operation. Do not cover the compressor with a blanket or towel etc., during use.

### ***(Risk of electrical shock)***

- ☑ Never unplug the power cord with wet hands.
- ☑ The compressor and power cord are not waterproof. Do not spill water, or other liquids, on these parts. If liquid does spill on these parts, immediately unplug the power cord and wipe off the liquid with gauze or other absorbent material.
- ☑ Do not use or store the device in humid locations, such as a bathroom.
- ☑ Do not immerse the main unit in water or other liquid.

Although this device fulfils the provisions of the EMC (Electromagnetic Compatibility) directive, the use of it should be avoided in direct vicinity of other electric devices.

### ***(Maintenance and Storage)***

- ☑ Store the device and accessories in a clean location.
- ☑ Always rinse the nebulizing parts with clean hot tap water after disinfecting them. Never leave the cleaning solution in the nebulizing parts.
- ☑ Be sure to wash the parts after use, and dry the parts immediately after washing them.
- ☑ Keep the device out of the reach of unsupervised infants and children. The device may contain small pieces that can be swallowed.
- ☑ Do not store the air tube while there is moisture or medication remaining inside it.

# IMPORTANT SAFETY NOTES

## **⚠ CAUTION:**

Indicates a potentially hazardous situation which if not avoided, may result in minor or moderate injury, or physical damage.

### ***(Usage)***

- ☑ Provide close supervision when this device is used by, on, or near children or invalids.
- ☑ Make sure that the baffle, air filter, and other parts are attached correctly.
- ☑ Make sure that the air filter is clean. If the air filter has changed colour, or has been used on average for more than 60 days, replace it with a new one.
- ☑ Do not tilt the nebulizer kit so that it is at an angle of greater than 45°, or shake it while in use.
- ☑ Do not use or store the device while the air tube is bent.
- ☑ Approved for human use only.
- ☑ Use only original OMRON parts and accessories. Use of unsupported parts may damage the device.
- ☑ Do not add more than 7 ml of medication to the medication cup.
- ☑ Do not drop the compressor or nebulizer kit, or subject them to strong shocks.
- ☑ Do not distort the baffle, or jab the nozzle of the medication cup with a pin etc.
- ☑ Do not insert fingers or objects inside the compressor.
- ☑ Do not block the air filter cover.
- ☑ Do not disassemble or attempt to repair the compressor or power cord.
- ☑ To avoid injury to the nose mucosa, do not squeeze the nosepiece into the back of the nose.
- ☑ Do not block the slit between the cap and the inhalation air inlet.
- ☑ Do not use a microwave oven or hair dryer to dry the nebulizing parts.
- ☑ Changes or modifications not approved by OMRON Healthcare will void the user warranty.

### ***(Risk of electrical shock)***

- ☑ Plug the device into the appropriate voltage outlet. Do not overload power outlets or use extension cords.
- ☑ Always unplug the device from the power outlet after use.
- ☑ Always disconnect the power cord before cleaning.

### ***(Maintenance and Storage)***

- ☑ Do not carry or leave the nebulizer while the medication cup contains medication.
- ☑ When sterilizing parts by boiling, make sure that the container does not boil dry.

# IMPORTANT SAFETY NOTES

- ☑ Never place, or attempt to dry the compressor, the power cord or nebulizing parts in a microwave oven.

## **General Safety Precautions:**

- ☑ Inspect the device and parts before using them each time, and check that there are no problems. In particular, be sure to check the following:
  - That the baffle, nozzle or air tube are not damaged.
  - That the nozzle is not blocked.
  - That the compressor operates normally.
- ☑ When using this device, there will be some noise and vibration caused by the pump in the compressor. There will also be some noise caused by the emission of compressed air from the nebulizer kit. This is normal and does not indicate a malfunction, or reduce the working life of the device.
- ☑ Operate the device only as intended. Do not use the device for any other purpose.
- ☑ Do not use the device at temperatures greater than +40°C.
- ☑ Dispose of the device and any used accessories or optional parts according to applicable local regulations. Unlawful disposal may cause environmental pollution.

# KNOW YOUR UNIT

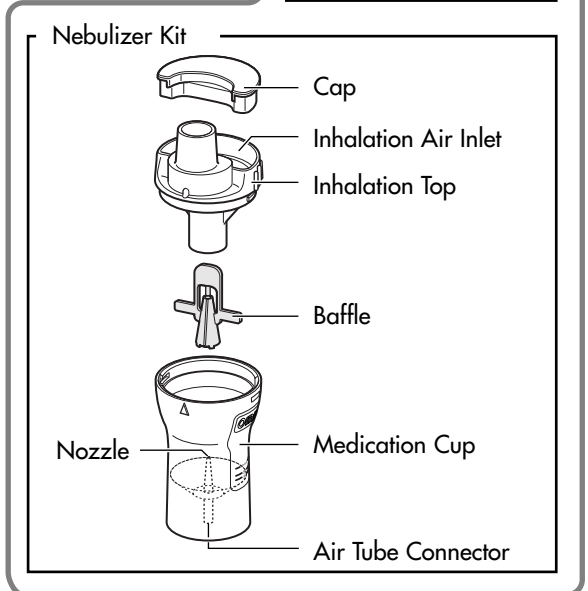
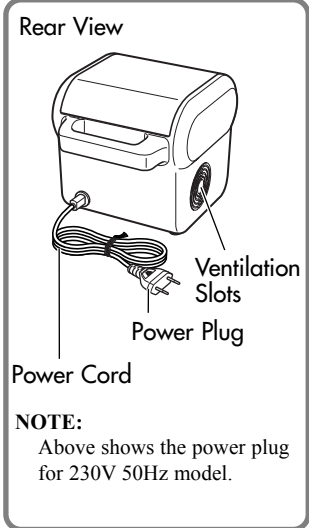
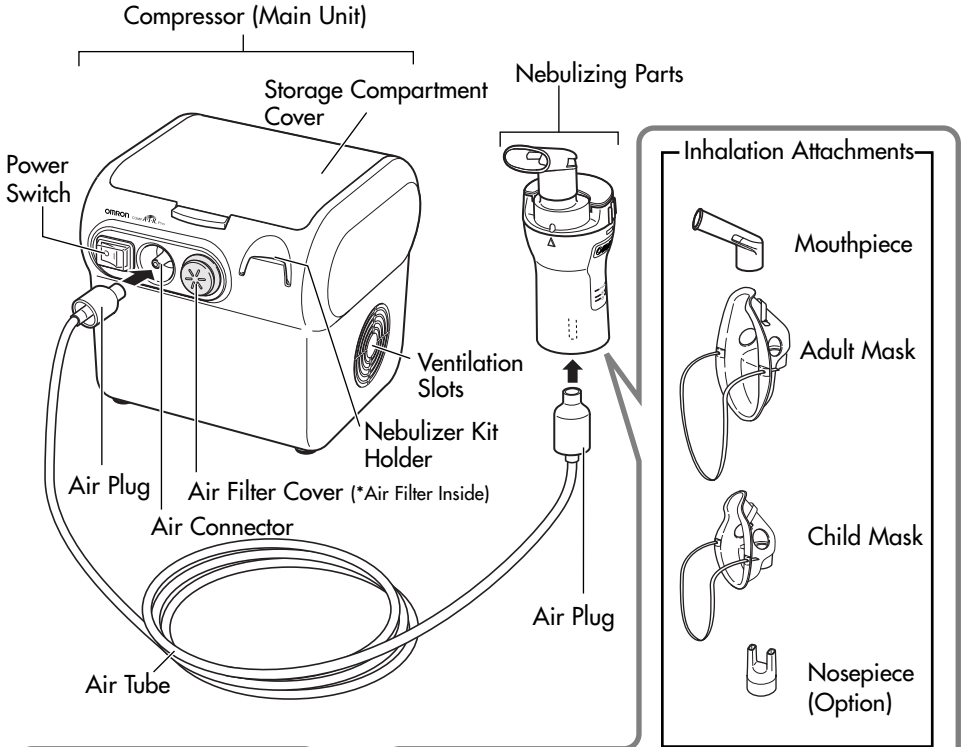

# KNOW YOUR UNIT

## Accessories:

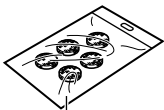

Spare Air Filters x 5



Instruction Manual

# GUIDE TO USING THE NE-C29

## HOW TO PREPARE THE NEBULIZER FOR USE (Page 8)

### NOTE:

Clean and disinfect the nebulizer kit and applicable inhalation attachments before using the device for the first time, or if it has not been used for a while.



## HOW TO TAKE MEDICATION (Page 12)

### NOTES:

- Do not tilt the nebulizer kit so that it is at an angle of greater than 45°.
- Do not bend or fold the air tube.

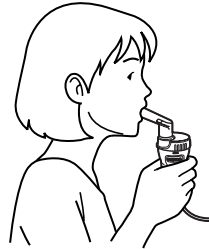

## HOW TO CLEAN PARTS AFTER USE (Page 15)

### NOTE:

Failure to clean the nebulizing parts after use may lead to infection.

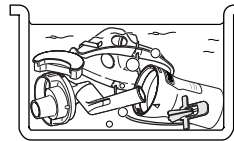

## HOW THE NEBULIZER KIT WORKS

The compressed air from the compressor is forced through the nozzle, as it does so, it is mixed with the medication in the baffle and forced upwards. The medication is then turned into a fine aerosol and directed upwards by the baffle, where it is broken down into many smaller aerosol particles.

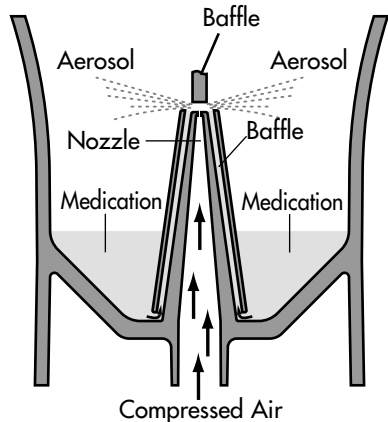

# HOW TO PREPARE THE NEBULIZER FOR USE

## ⚠ WARNING:

Clean and disinfect the nebulizer kit, mouthpiece and optional nosepiece or masks before using them for the first time after purchase, if the device has not been used for a long period of time.

For directions on cleaning and disinfecting the parts of the device refer to page 15 in this instruction manual.

## NOTE:

Make sure that the air filter is changed regularly. (See “How to Change the Air Filter” on page 18.)

1. Make sure that the power switch is turned off.

Check that the power switch is in the  position.

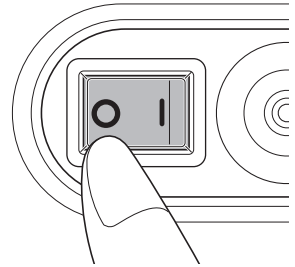

2. Plug the power plug into a power outlet.

3. Remove the mouthpiece and cap from the nebulizer kit.

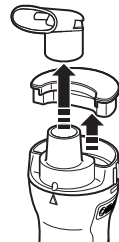

4. Remove the inhalation top from the medication cup.

- 1) Rotate the inhalation top counter clockwise.
- 2) Lift the inhalation top out of the medication cup.

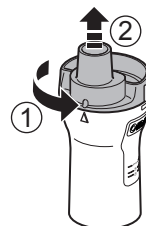

# HOW TO PREPARE THE NEBULIZER FOR USE

5. Remove the baffle from the medication cup.

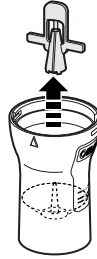

6. Add the correct amount of prescribed medication to the medication cup.

**⚠ CAUTION:**

**The capacity of the medication cup is 2 to 7 ml.**



7. Reattach the baffle to the medication cup.



8. Put the inhalation top back inside the medication cup.

- 1) Align the protrusion on the inhalation top with the indent on the medication cup, as shown.
- 2) Rotate the inhalation top clockwise and align with the medication cup until they click in place.

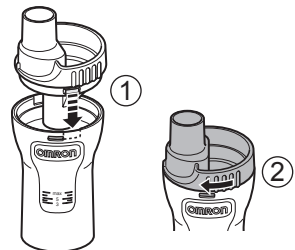

# HOW TO PREPARE THE NEBULIZER FOR USE

9. Attach the desired inhalation attachment, as described below.

Attach the cap when using the mouthpiece or optional nosepiece. Using the cap with these attachments will reduce the amount of medication that is discharged into the air.

## *Attaching the Mouthpiece*

- 1) Attach the cap to the inhalation air inlet.
- 2) Attach the mouthpiece to the inhalation top.

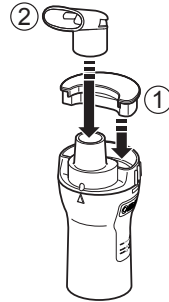

## *Attaching the Adult Mask*

Attach the mask to the inhalation top.

### **NOTE:**

Do not attach the cap.

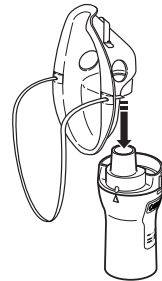

## *Attaching the Child Mask*

Attach the mask to the inhalation top.

### **NOTE:**

Do not attach the cap.

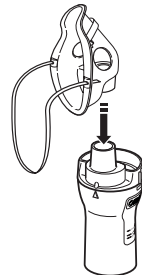

## *Attaching the Nosepiece (Option)*

- 1) Attach the cap to the inhalation air inlet.
- 2) Attach the nosepiece to the inhalation top.

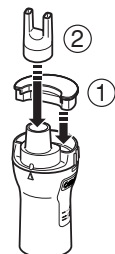

# HOW TO PREPARE THE NEBULIZER FOR USE

10. Attach the air tube.

- 1) Attach the air tube to the air connector on the compressor.
- 2) Attach the other end of the air tube to the air tube connector on the medication cup.

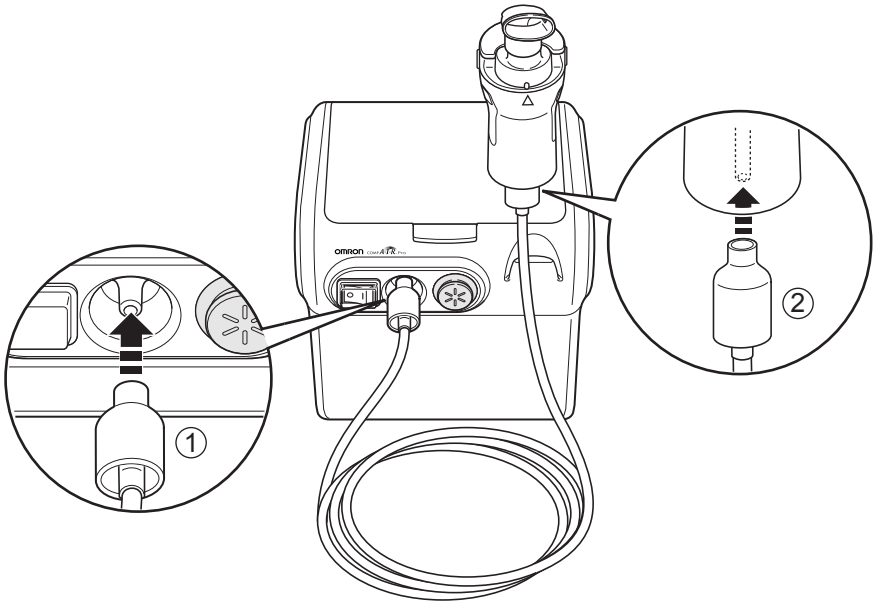

## NOTES:

- Make sure that the air tube is securely connected. Otherwise, air may leak from the air tube during use.
- Take care not to spill the medication when attaching the air tube. Keep the nebulizer kit upright.
- Use the nebulizer kit holder as a temporary holder for the nebulizer kit.

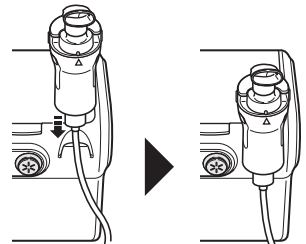

# HOW TO TAKE MEDICATION

1. Hold the nebulizer kit as indicated on the right.

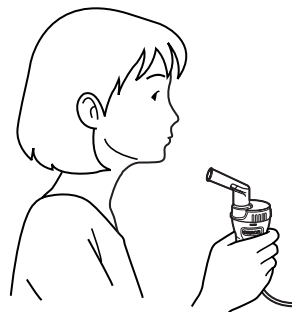

## ⚠ CAUTION:

Do not tilt the nebulizer kit so that it is at an angle of greater than 45°. Medication may flow into the mouth.

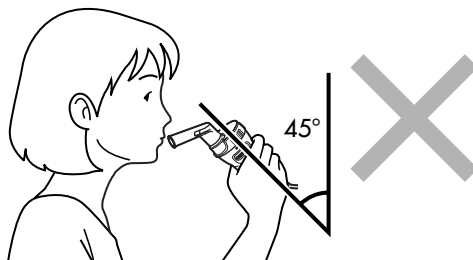

2. Press the power switch to the on (I) position.

The compressor starts and nebulization starts.

## NOTE:

Perform functional test, observe whether aerosol is generated.

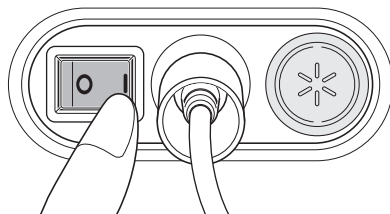

## *To stop nebulization*

Press the power switch to the off (O) position.

## ⚠ WARNING:

Do not block the ventilation slots on the compressor. This could result in the compressor overheating or malfunctioning.

## ⚠ CAUTION:

Do not block the air filter cover.

# HOW TO TAKE MEDICATION

- Inhale medication as according to your doctor's and/or health care adviser's instructions.

## *Using the Mouthpiece*

Insert the mouthpiece into your mouth and inhale the medication breathing normally. Exhale as normal through the mouthpiece.

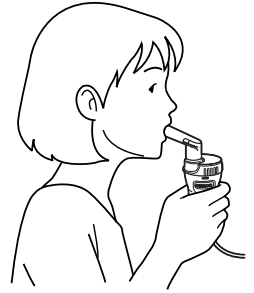

## *Using the Adult Mask*

Attach the mask so that it covers your nose and mouth and inhale the medication. Exhale as normal through the mask.

### **NOTE:**

If the amount of aerosol is too great, attach the cap.

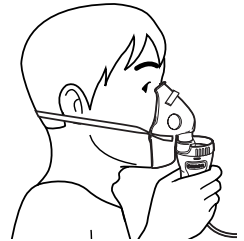

## *Using the Child Mask*

Attach the mask so that it covers your nose and mouth and inhale the medication. Exhale as normal through the mask.

### **NOTE:**

If the amount of aerosol is too great, attach the cap.

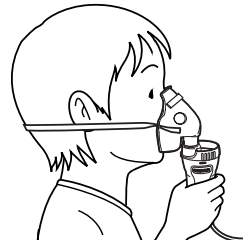

## *Using the Nosepiece (Option)*

Inhale the medication through the nosepiece, as shown and exhale through the mouth.



# HOW TO TAKE MEDICATION

## 4. Complete your treatment.

- 1) When you have finished inhaling your medication, turn the compressor off.

Press the power switch to the off  position.

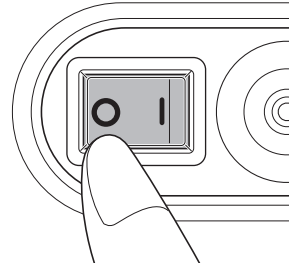

- 2) Unplug the air tube from the nebulizer kit.

### **NOTE:**

Always hold the air plug when disconnecting the air tube.

- 3) Check that there is no condensation or moisture remaining in the air tube.

**If there is moisture or liquid remaining in the air tube, be sure to follow the procedure below to remove any moisture from within the air tube.**

- i) Make sure that the air tube is still connected to the air connector on the compressor.
- ii) Turn on the compressor and pump air through the air tube to expel the moisture.

- 4) Unplug the air tube from the compressor.

### **⚠ WARNING:**

**Condensation may occur in the air tube. Do not store the air tube while it contains condensation or moisture. This could result in infection via bacteria.**

- 5) Unplug the device from the power outlet.

# CLEANING AND DAILY DISINFECTING

Following the cleaning instructions after each use will prevent any remaining medication in the bottle from drying resulting in the device not nebulizing effectively and also for preventing infections.

## **⚠ WARNING:**

**Be sure to wash the parts after use, and dry the parts immediately after washing them.**

1. Remove the nebulizer kit from the air tube and disassemble the nebulizer kit. Separate the inhalation attachment and the nebulizer kit, and disassemble the nebulizer kit. (See page 8)
2. Discard any remaining medication in the medication cup.

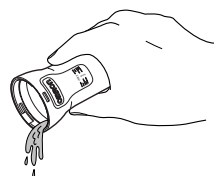

3. Wash all the parts of the nebulizing parts in warm water and mild detergent, or wash in a dishwasher. For instructions on how to disinfect the parts, see the following section.
4. After cleaning and disinfecting the parts, rinse them thoroughly with clean water and allow the parts to air dry in a clean environment.

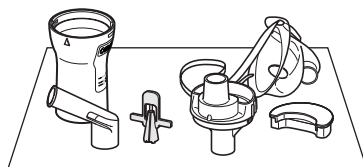

## **Disinfecting the Parts of the Nebulizing Parts**

Always disinfect the medication cup, mouthpiece and other parts of the nebulizing parts after the last treatment of the day. To disinfect the parts, use one of the methods described below:

- A.** Use a commercially available disinfectant. Follow the instructions provided by the disinfectant manufacturer.
- B.** Parts may be boiled for more than 15 minutes (except for mask).
  1. Submerge the parts in the cleansing solution for the specified period.
  2. Remove the parts and discard the solution.
  3. Rinse the parts with clean hot tap water.

# MAINTENANCE AND STORAGE

1. Assemble the nebulizing parts.
2. If the compressor is dirty, wipe it clean with a soft cloth moistened with water or mild detergent.

**⚠ WARNING:**

**The compressor is not waterproof.**

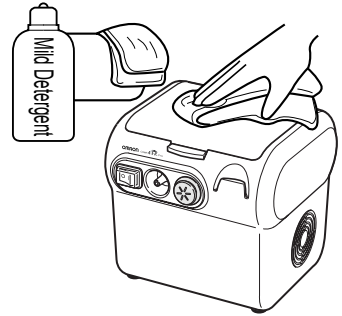

3. If the outside of the air tube is dirty, wipe it clean with a soft cloth moistened with water or mild detergent.
4. Store the parts in the storage compartment in the compressor.

**NOTE:**

Make sure that the parts are clean and dry. Do not place parts in the storage compartment if they are still wet.

5. Store the unit in a clean location.

**NOTE:**

Nebulizer kit should be replaced after using for 6 months.

# MAINTENANCE AND STORAGE

To keep your device in the best condition and protect the device from damage follow these directions:

## ⚠ CAUTION:

- **Do not drop the compressor or nebulizer kit, or subject them to strong shocks.**
- **Do not carry or leave the nebulizer while the medication cup contains medication.**

## NOTES:

- Do not store the device in extreme hot or cold temperatures, high humidity or under direct sunlight.
- Dispose of the device and any used accessories or optional parts according to applicable local regulations.
- Never clean with benzene, thinner or a flammable chemical.

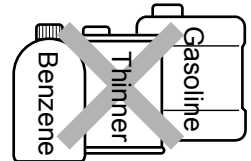

# HOW TO CHANGE THE AIR FILTER

If the air filter becomes dirty, or has water or medication spilled on it, replace the air filter with a new one. On average, the air filter should be changed every 60 days even if it does not appear dirty.

1. Pull the air filter cover off the compressor.

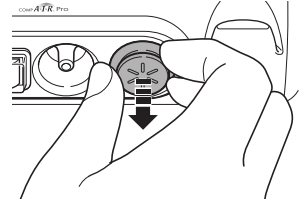

2. Change the air filter.

Remove the old air filter with a sharp object, such as a toothpick, and insert the new air filter.

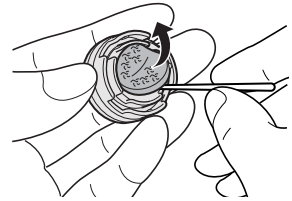

3. Put the air filter cover back in place.

## NOTES:

- Use only OMRON air filters designed for this unit. Do not operate without a filter.
- There is no front or back orientation for the air filters.
- Check that air filters are clean and free of dust before inserting them.
- Do not attempt to wash or clean the filter. If the air filter becomes wet, replace it. Damp air filters can cause blockages.
- To prevent the mesh of the air filter cover becoming blocked, wash the cover regularly. Do not boil the air filter cover. Remove the air filter cover, wash it, and make sure it is dry and reattached correctly.
- Please contact your OMRON dealer for additional air filters, or if the parts supplied with the device are damaged or missing.

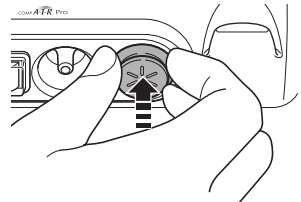

# TROUBLESHOOTING TIPS

Check the following if your unit should fail during operation. You can also refer to the pages of this manual for complete instructions.

PROBLEM	CAUSE	REMEDY
Nothing happens when the power switch is pressed.	Is the power plug plugged into an electrical outlet?	Check that the plug is inserted in an electrical outlet. Unplug then reinsert the plug if necessary.
No nebulization or low nebulization rate, when the power is on.	Is there medication in medication cup?	Fill the medication cup.
	Is there too much/little medication in the medication cup?	Add the correct amount of medication to the medication cup.
	Is the baffle missing and not assembled correctly?	Attach the baffle correctly.
	Is the nebulizer kit assembled correctly?	Assemble the nebulizer kit correctly.
	Is the nozzle blocked?	Make sure that the nozzle is free of blockages.
	Is the nebulizer kit tilted at a sharp angle?	Make sure that the nebulizer kit is not tilted at an angle of more than 45 degrees.
	Is the air tube connected correctly?	Make sure that the air tube is correctly connected to the compressor and nebulizer kit.
	Is the air tube folded or damaged?	Make sure that the air tube does not contain kinks.
	Is the air tube blocked?	Make sure that the air tube is free of blockages.
	Is the air filter dirty?	Replace the air filter with a new one.
The device is abnormally loud.	Is the air filter cover attached correctly?	Attach the air filter cover correctly.
The device is very hot.	Are the ventilation slots blocked?	Do not block the ventilation slots.

**NOTES:**

- If the suggested remedy does not solve the problem, do not try to repair the device - no parts of the unit are user serviceable. Return the unit to an authorized OMRON dealer.
- The device should be serviced once a year by an approved OMRON service centre.

# SPECIFICATIONS

Model:	NE-C29
Type:	Non-heating compressor nebulizer
Electrical:	230V, 50Hz model ; 230V, 60Hz model
Power Consumption:	138VA
Nebulizer Rate:	0.4 ml/min (without cap)
Particle Size:	*MMD approximately 5 $\mu\text{m}$ (based on EN13544-1)
Medication Cup Capacity:	7 ml (cc) max.
Appropriate Medication Quantities:	2 - 7 ml (cc)
Operating Temperature/ Humidity:	+10°C to +40°C, 30% to 85% RH
Storage Temperature/ Humidity:	-20°C to +60°C, 10% to 95% RH
Weight:	Approx. 2.3kg (compressor only)
Dimensions:	Approx. 186mm (w) $\times$ 180mm (h) $\times$ 216mm (d)
Contents:	Compressor, Nebulizer Kit, Air Tube, 5 pcs Replacement Filters, Mouthpiece, Adult Mask, Child Mask, Instruction Manual.

\*MMD = Mass Median Diameter

## NOTES:

- Subject to technical modification without prior notice.
- Please note that specifications may vary with medication type used.
- Do not use the device where it may be exposed to flammable gas.
- This unit confirms to EMC Standard IEC60601-1-2:2001. However, if it is used together with other medical devices or electrical equipment, they may influence the operations of one of devices. Please follow any instructions in the manuals and use all devices correctly.

 = Type B

 = Class II



# OPTIONAL PARTS AND ACCESSORIES

## Nebulizer Kit Set

Model No. C28NEBKIT

Nebulizer Kit

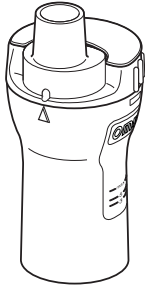

Mouthpiece

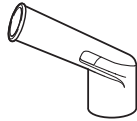

## Nosepiece

Model No. C28NP



## Air Tube

Model No. C30TUBE

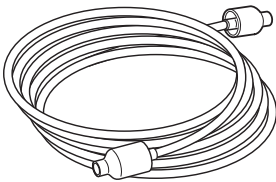

## Mouthpiece

Model No. C28MP



## Filter Cover

Model No. C28FLCVR



## Adult Mask

Model No. C28AM

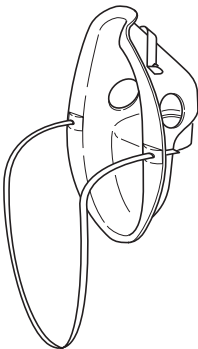

## Child Mask

Model No. C28CM

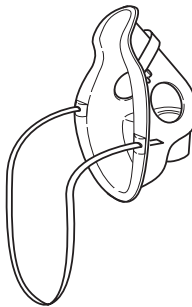

## Air Filters (x 5)

Model No. C28FL

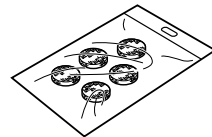

# NOTES